



Smart Monitoring System

**Owner's Manual**

# Contents

|   |   |                              |   |
|---|---|------------------------------|---|
| System Overview .....                           | 1 | System Operation.....        | 3 |
| System Features Overview .....                  | 1 | Ongoing Spa Maintenance..... | 5 |
| Best Practice Start-Up Process.....             | 2 | Troubleshooting.....         | 6 |
| Initial Set Up of Smart Monitoring System ..... | 2 | Customer Service.....        | 7 |

## Safety Information (Read, Follow, and Save All Instructions)

**WARNING:** Operate the Smart Monitoring System only according to these instructions. The system is designed to be exclusively used with the FreshWater Salt System. Do not use other chemical systems with the spa.

**WARNING:** Do not use the following products with Smart Monitoring System: FreshWater Mineral Spa Sanitizer or other silver nitrate products, ozone, bromine or MPS.

**WARNING:** Do not energize or operate the unit if the cartridge housing is damaged or improperly assembled.

**WARNING:** Do not operate the Smart Monitoring system in the unlocked position, controller and sensor must be installed per installation instructions.

**WARNING:** Do not operate the spa without water.

**WARNING:** To reduce the risk of electric shock, replace damaged cords or components immediately.

**WARNING:** Remove power from the spa before performing any maintenance or troubleshooting.

**CAUTION:** To avoid damage, DO NOT insert any foreign objects into the system housing.

**CAUTION:** Prior to using the spa, check water parameters and treat and adjust as necessary.

**CAUTION:** NOT compatible with bromine or BaquaSpa® (biguanide).

**CAUTION:** Do not use Calcium Hypochlorite or Trichlor tablets with system.

**CAUTION:** Do not use splash-free or scented liquid chlorine or bleach.

**NOTE:** The system must be used in conjunction with FreshWater Salt System. When using the spa, the chlorine level must be maintained between 1-5 ppm. Supplement sanitizer generation with Sodium Dichlor (chlorine), liquid Sodium Hypochlorite (chlorine), only as needed.

**DISCLAIMER:** This is not an automatic water care system. Supplemental use of FreshWater 5-way Test Strip is recommended in order to maintain proper Alkalinity and Calcium Hardness.

Carefully review the entire Owner's Manual before using the Smart Monitoring System, and keep this manual available for reference. If you have any questions about your Smart Monitoring System setup, operation, or maintenance, contact your authorized dealer.

**THE SPA OWNER IS ULTIMATELY RESPONSIBLE FOR  
MAINTAINING PROPER SANITARY WATER CONDITIONS.**

### VERY IMPORTANT:

Before Installing the FreshWater Smart Monitoring System:

- The FreshWater Salt System MUST be completely installed.
- The FreshWater Salt System MUST be up and running, generating chlorine, and holding the required residual ppm.
- Once the Smart Monitoring System controller and sensor are installed it may take 24 hours before the Smart Monitoring System is fully functional.

## System Overview

FreshWater Smart Monitoring System is used to monitor the spa water quality in order to simplify your water care management:

- Measures and displays water quality for: Chlorine, Salt and pH levels
- Displays FreshWater Monitoring System Sensor life and FRESHWATER Salt cartridge life
- Provides users access to water care status via the topside control.
- Takes measurements every hour to ensure the most accurate information.
- Provides feedback and recommendations to manage water chemistry (Chlorine, pH & Salt).
- With proper water care, the sensor can last up to 12 months.

**IMPORTANT:** Smart Monitoring System will **ONLY WORK** when Salt System is installed and operational.

- **Smart Monitoring System Housing and Cap** - The bartop accessible housing and cap holds the FreshWater Smart Monitoring System allowing for easy replacement.



- **Smart Monitoring System Plug** - This is a factory installed non-functional plug inside the Smart Monitoring System Housing and should not be removed until you are ready to install the assembled controller and sensor. Follow the start-up guide that comes with the sensor to install for the first time. Keeping this plug is recommended.



- **Smart Monitoring System** - Installed in the housing, easily accessible from the top of your spa, the system is comprised of a controller and a replaceable sensor.



## System Features Overview

The Smart Monitoring System monitors your water throughout the day and updates the Chlorine, pH, and Salt displays on an hourly basis. FreshWater 5-Way test strips should be used to test and maintain alkalinity and calcium levels at start-up and every two weeks.

Depending on your spa model one of these 2 screens will appear once you enter the water care screen.

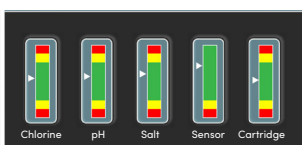

Touch Screen Display



Button Display

## Chlorine

The chlorine level in the spa is displayed in the labeled status indicator. The green band represent 1-5 ppm.

If you have a touch screen display press the Chlorine status indicator, if not then press:

- Chlorine soft button



## pH

The pH level in the spa is displayed in the labeled status indicator.

The green band represent 7.2 - 7.8.

If you have a touch screen display, press the pH status indicator, if not then press:

- pH soft button



## Salt

The salt meter has low red, low yellow and green bands to provide status on the amount of salt added to the spa water during the FreshWater Salt start-up process. It is recommended to add FreshWater Spa Salt to keep the level in the middle green band. If the salt indicator is outside of the green band, follow the on-screen recommendations, to either partially drain the spa if in high yellow or high red or to add additional spa salt if in low yellow or low red.

If you have a touch screen, press the Salt status indicator, if not then press:

- OPTION hard button
- Water Care soft button
- Salt soft button



## Smart Monitoring Sensor

The Smart Monitoring Sensor life is displayed in the labeled Sensor indicator. Over the life of the sensor, the indicator will slowly drop towards yellow. Once the indicator reaches yellow, the sensor has approximately 2 months of life remaining. When the indicator reaches red, it is time to replace the sensor. The monitoring system will stop taking readings once the indicator is in the red.

If you have a touch screen display, press the Sensor status indicator, if not then press:

- NEXT soft button
- Sensor soft button.

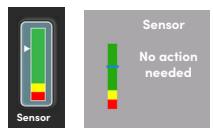

## Salt Cartridge

The cartridge display represents the FreshWater Salt System cartridge life when Smart Monitoring System is installed and turned on.

If you have a touch screen display, press the Cartridge status indicator, if not the press:

- NEXT soft button
- FreshWater Salt System soft button.

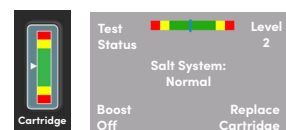

## Best Practice Start-up Process

It is recommended to install the FreshWater Salt System and have it **fully** operational first before installing the Smart Monitoring System. If the Smart Monitoring System is installed at the same time, the Smart Monitoring System should be turned **off**. To turn off the Smart Monitoring System:

### Touch screen display

- Press the Sensor status indicator
- Move System button to Off position

### Button display

- Press NEXT soft button
- Press Sensor soft button.
- Press System Off Soft button.

If the Smart Monitoring system is installed and / or turned on prior to the FreshWater Salt System being fully operational, the system will have incorrect recommendations for chlorine, pH and salt.

1. Install the FreshWater Salt System Cartridge using the instructions provided with the FreshWater Salt System Owner's Manual.
2. Using the Salt System Manual, follow and complete the entire Getting Started section. **NOTE**, it is important that initial chlorination must be 5 ppm residual.
3. Spa water must be holding at 3ppm daily, chlorine range and target may vary by country. Consult local authority.

### DO

- Test and balance spa water
- Maintain water within target parameters
- Make sure FreshWater Salt startup process is complete
- Test and treat for metals as needed
- Use FreshWater 5-way and FreshWater Salt test strips during FreshWater salt start up & follow-up Initial chlorination, pH and Salt level
- Continue to use 5-way test strips every two weeks to test for:
  - a. Test for Calcium hardness
  - b. Test for Alkalinity levels
- Continue to use FreshWater Phosphate test strips every two weeks to test for phosphates
- Manage phosphate levels with FreshWater phosphate remover

It is recommended to have your source water tested prior to FreshWater Salt System installation.

### DON'T

- Use FreshWater mineral spa sanitizer or other silver nitrate products.
- Use Ozone
- Use Bromine
- Use MPS

Once the FreshWater Salt System is fully operational, install the Smart Monitoring System per instructions.

**WARNING: False readings will occur if the Smart Monitoring System is activated before start-up is complete. The Smart Monitoring system will not be accessible if the FreshWater Salt system is not installed or not turned on (Output Level 0).**

## Initial Set Up Of Smart Monitoring System

Turn power to spa off (reference Spa Owner's Manual)

**NOTE: You will need a Phillips head screwdriver**

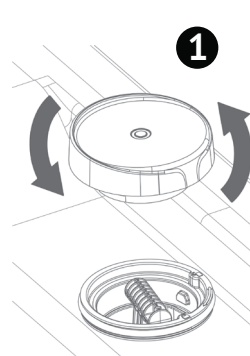

Rotate the Smart Monitoring cap counterclockwise and lift up to remove.

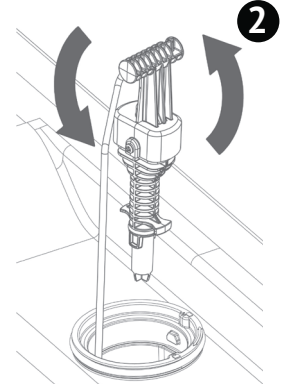

Rotate the Smart Monitoring plug counterclockwise to the unlock position and lift out.

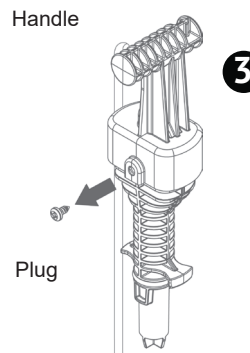

Using the Phillips head screwdriver, carefully remove the screw and separate the plug from the handle.

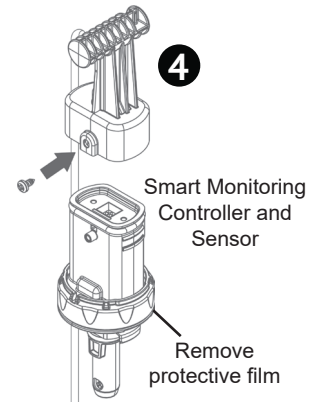

Fit the pre-assembled controller and sensor to the handle and replace the screw.

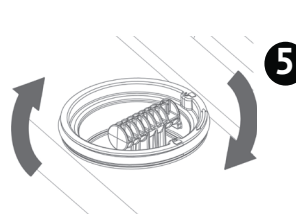

Align the handle arrow to the unlock position, fully insert into the housing, push down to fully insert into the housing, and rotate clockwise to the lock position.

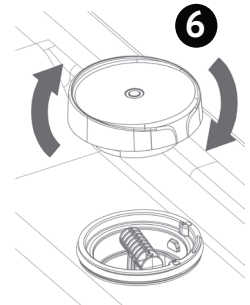

Replace the Smart Monitoring cap and turn clockwise to tighten. Turn Power to spa back on (reference Spa Owner's Manual).

**IMPORTANT:** The Smart Monitoring System will take 24 hours to become fully operational. The chlorine and pH values will not be displayed during that time and "24 hour initialization period" is displayed. The salt values will be shown.

# System Operation

## Home Screen

The spa home screen is the entry into the Smart Monitoring System.

For touch panel equipped spas, a water care droplet icon is present to access the Smart Monitoring System.

Button panels use the Options hard button to access WaterCare menu. The icon will light up or “Watercare” will be shown yellow or red depending on the panel when attention is needed.

## Dashboard

The touch panel WaterCare dashboard illustrates the five core features of the Smart Monitoring System in status meter format. Each meter is a pressable button used to access a detail recommendation screen for Chlorine, pH, Salt, and Sensor, while Cartridge accesses the FreshWater Salt System (Salt System) control. When a value for one of the values is in yellow or red, a colored indicator will appear on the meter to direct the user to review the details of the parameter.

For the button control panels, the WaterCare menu items are broken down into a main screen offering Chlorine, pH, Salt and a second screen offering Sensor and Cartridge access. Each parameter menu item will change to yellow or red when the parameter value moves into the yellow or red band.

## Notification management

Individual parameter meters or menus will change color when attention is needed from the user. Although the individual parameters will show their represented state, the Spa home screen will show a single indicator with red being shown in priority over yellow parameters.

The individual notifications are cleared when the detailed parameter recommendation screen is viewed. Notifications that have been cleared will not be reposted for 24 hours to allow time for changes to the water to take effect. If after 24 hours the parameter is still in yellow or red, the notification will be presented again. Otherwise, if the parameter is in the green band, no notification will be shown.

## Operation and Parameter Recommendations

It is important to start-up and maintain the spa water and Salt System as directed in the Salt System manual and best practices. The Smart Monitoring system, which works in conjunction with the Salt System, requires the same water chemistry and maintenance for best performance. Smart Monitoring System provides feedback on chlorine, pH, and salt values. Test strips are needed to properly balance the water and adjust calcium hardness and alkalinity.

| System Parameter | Target    | OK Range  |           |
|------------------|-----------|-----------|-----------|
|                  |           | Min       | Max       |
| Salt             | 1,750 ppm | 1,500 ppm | 2,000 ppm |
| Hardness         | 50 ppm    | 25 ppm    | 75 ppm    |
| Alkalinity       | 80 ppm    | 40 ppm    | 120 ppm   |
| pH               | 7.4       | 7.2       | 7.8       |
| Chlorine*        | 3 ppm     | 1 ppm     | 5 ppm     |
| Phosphates       | <150 ppb  | 0 ppb     | 300 ppb   |

\*Chlorine range and target may vary by country. Consult local authority.

**Chlorine** is the primary parameter needed to keep the water safe and sanitized. The Salt System generates chlorine from the salt added to the water and the amount produced is controlled by the output level. When the output level matches the chlorine demand, the parameter will display in the green. If the output is low (not enough chlorine residual), the display will fall into the low yellow or red. If the output is high (excessive chlorine residual), the display will increase into the high yellow or red.

| Chlorine   | Status      | Recommendation                       |
|--|-------------|--------------------------------------|
|  | High Red    | Decrease output level by 2           |
|  | High Yellow | Decrease output level by 1           |
|  | Green       | No Action needed                     |
|  | Low Yellow  | Increase output level by 1           |
|  | Low Red     | Increase output level by 1 and boost |

Recommendations are provided to adjust the Salt System output to help maintain values in the green band. The user is required to adjust the Salt System as needed to maintain a chlorine residual.

**pH** is an important parameter affecting the effectiveness of the generated chlorine. It is controlled by adding FreshWater pH Up and FreshWater pH Down. Depending on water conditions, usage, and chlorine generation rate, the pH will drift upwards and need periodic adjustment. When the Smart Monitor detects that the pH is out of the green band, guidance will be provided to correct the reading. It is important to first focus on keeping the chlorine value in the green as this can affect the pH reading. Also after making a pH correction, allow the system 24 hours to equilibrate before adding a follow-up dose.

| pH  | Status      | Recommendation   |
|---|-------------|--|
|  | High Red    | Add 3 tsp pH Down and wait 24 hours before adding more |
|   | High Yellow | Add 1 tsp pH Down and wait 24 hours before adding more |
|   | Green       | No Action needed                                       |
|   | Low Yellow  | Add 1 tsp pH Up and wait 24 hours before adding more   |
|   | Low Red     | Add 3 tsp pH Up and wait 24 hours before adding more   |

The **SALT** parameter is an important value used by both the Smart Monitoring System as well as the Salt System. The salt status indicator reflects the amount of spa salt added to the spa water. Maintaining a value in the center of the green band is optimal for the system performance. Add salt per the Salt System start up process and make adjustments once the Smart Monitor is online. The indicator updates hourly to allow time for the adjustment to take effect.

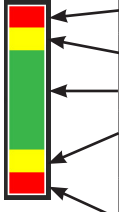
| Salt  | Status      | Recommendation   |
|---|-------------|--|
|  | High Red*   | Drain 25% of water and refill. Test salt and all water system levels |
|   | High Yellow | Monitor salt level   |
|   | Green       | No Action needed   |
|   | Low Yellow  | Add 1 cup of salt and run jets for 10 minutes                        |
|   | Low Red     | Add 2 cups of salt and run jets for 10 minutes                       |

\* Recommend to turn off spa during drain and refill

The Salt System cartridge performance and operation is dependent on adding the correct amount of salt to the spa.

The **Smart Monitor** sensor displays the unit's life and condition. The Monitor tests the water on an hourly basis and reports the latest information, including the monitor condition to the spa. The monitor detail screen provides the operation recommendations as well as any conditions or errors that are encountered.

| Sensor  | Status | Recommendation     |
|---|--------|--------------------|
|  | Green  | No Action needed   |
|   | Yellow | Prepare to replace |
|   | Red    | Replace cartridge  |

**FreshWater Salt** Water operation is enhanced with the addition of the Smart Monitor System. To access the full set of Salt System functions, press the Cartridge menu icon/button. See the Salt System manual for explanation of the system. **NOTE**, the Smart Monitor's dedicated Salt meter provides separate guidance to maintain the correct salt level.

| Cartridge   | Status      | Recommendation**                          |
|---|-------------|---|
|  | High Red    | Not applicable when system is installed   |
|   | High Yellow |   |
|   | Green       | No Action needed                          |
|   | Low Yellow  | Prepare to replace                        |
|   |             | Increase water temperature over 95°F/35°C |
|   | Low Red     | Replace cartridge now                     |
|   |             | Adjust salt level                         |
|   |             | Increase water temperature over 95°F/35°C |
| System off  |             |   |

\*\* Messaging with Smart Monitor installed. See the Salt System manual for messaging and operation without the Smart Monitor.

Salt System Messaging with Smart Monitoring System active:

| Message                                  | Remark  |
|--|---|
| System initializing                      | Waiting for information from the Smart monitor  |
| No action needed                         | Operating correctly   |
| Increase water temperature over +95F/35C | FWSS is reading low and the water temperature should be increased to verify operation |
| Adjust salt level                        | FWSS operating low due to low salt level in the water                                 |
| Prepare to replace cartridge             | Cartridge is wearing down and should be replaced                                      |
| Replace cartridge now                    | Cartridge has expired   |
| Inspect cartridge for damage             | Cartridge is operating out of range. Inspect it for damaged or bent electrodes        |

With Smart Monitoring System installed, the messaging and function of the status indicator changes to directly reflect the life of the cartridge. The system messaging is also updated to provide better guidance to make adjustments to the operation.

## Operational interference

There are a variety of water conditions that can interfere with the proper operation of the Smart Monitor System. Many conditions will result in an offset of the chlorine or pH reading, making the system chronically off by 1 ppm or more as compared to a test strip or reference measurement.

Other variables can cause the system to become erratic and values will change erratically test to test:

- Use of FreshWater Mineral Spa Sanitizer or other silver nitrate products can permanently offset readings.
  - ◊ Remove the silver device, drain and refill the spa, and replace the sensor.
- Use of MPS. Smart Monitoring System is not calibrated to this type of chemistry.
  - ◊ Stop use and allow up to one week for the MPS to dissipate.
- Use of ozone unit. System is not calibrated for ozone use.
  - ◊ Remove ozone unit from the spa.
- Excessive use of dichlor and CYA build up will dampen chlorine response.
  - ◊ Drain and refill the spa.
- Very low alkalinity will offset pH readings.
  - ◊ Increase alkalinity to within the recommended range.
- Fill water that has not been shocked following Salt System start-up process can cause an incorrect chlorine reading.
  - ◊ Shock the water at start-up per FreshWater Salt best practices.

- Regularly test for calcium and phosphate levels and treat as recommended per FreshWater Salt system.
- The system requires adequate water flow. Rinse and clean filters per the Spa Manual recommended schedule.
- If topping off spa water, treat for metals with the FreshWater Clean Screen pre-filter as needed.

**Winterizing the spa** – When the spa is winterized and drained, it is recommended to complete the winterization process and then remove the smart monitoring system from the housing and shake out excess water. Remove water in the bottom of the housing with a sponge or similar and reinstall the Smart Monitor.

### Important Additional Information

**WARNING:** Operating the Smart Monitoring System in the unlocked position can damage the sensor. The system will not operate correctly.

**WARNING:** To reduce the risk of injury, do not permit children to operate this device.

**WARNING:** Maintaining high salt and chlorine levels above recommended range can contribute to corrosion of spa equipment.

**IMPORTANT:** Use only original FreshWater Sensor part number 80202 when replacing the sensor.

### Lost Screw Replacement

If the screw that connects the sensor to the controller is lost and needs to be replaced you will be able to purchase a new one at your local hardware store. The specification of the screw are as follows:

- #8 x 3/8" pan head sheet metal stainless steel screw.
- OR
- M 4.2 x 9.5 mm pan head sheet metal stainless steel screw.

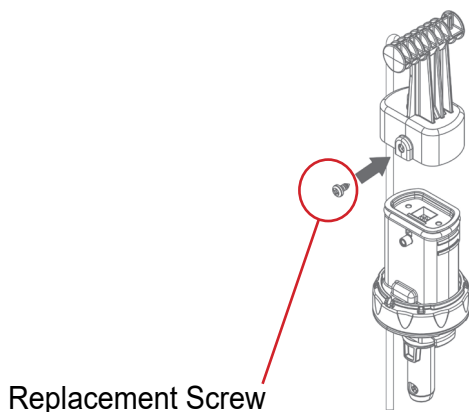

Replacement Screw

### Sensor Replacement

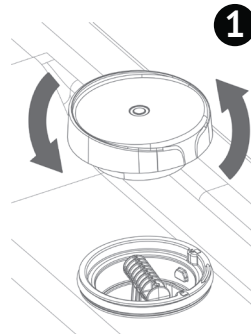

Turn power to spa Off. Rotate the Smart Monitoring cap counterclockwise and lift up to remove.

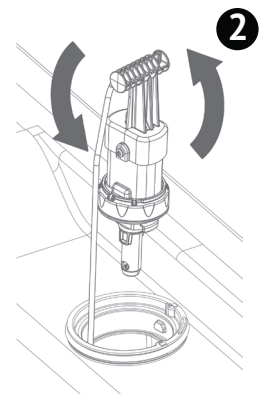

Rotate the Smart Monitoring controller with sensor counterclockwise to unlock and lift out.

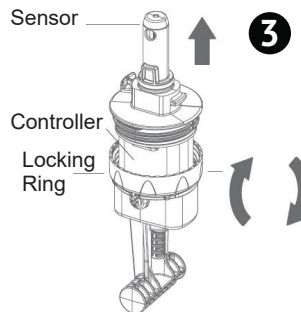

With the sensor pointing up, rotate the locking ring clockwise to release the sensor. Then remove the sensor.

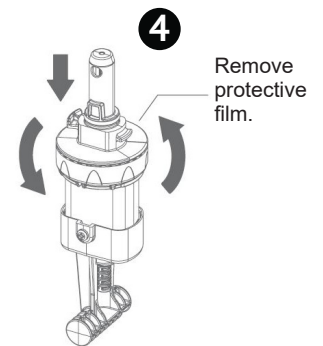

Attach the replacement sensor to the controller and rotate the locking ring counterclockwise to lock.

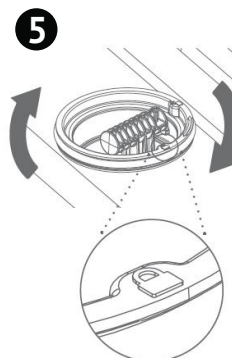

Align the handle arrow to the unlock position, fully insert into the housing, push down, and rotate clockwise to the lock position.

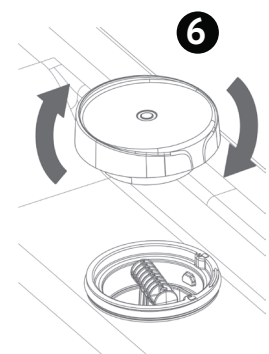

Replace the cap and turn clockwise to tighten. Turn the power to your spa back on.

**IMPORTANT:** The system will not work correctly unless the Smart Monitoring handle is fully rotated to the locked position.

## Troubleshooting

### Maintenance Checks

- Maintain the water to the recommended guidelines in the spa and FreshWater SALT SYSTEM manuals.
- Continue to monitor and address the FreshWater Salt System 10-Day timer.
- If the spa water, FreshWater SALT SYSTEM, or SMART MONITORING SYSTEM sensor have been exposed to products not recommended by Watkins Wellness or for example excessive oil based products or cosmetics, the SMART MONITORING SYSTEM performance may be impacted. The sensor electrodes, normally silver in color, can be covered in chemical contamination and take on a brown color or oily appearance and require replacement.

### No Chlorine Reading

The system cleans spa water differently than manually added chlorine. Since the water is cleaned before the chlorine residual is established, only a small chlorine residual is needed. If there appears to be no chlorine in the water:

- Check output level. If the spa is used frequently the FreshWater Salt System Output may need to be increased to a higher number.
- High Phosphates. Phosphate levels over 300 ppb can result in high chlorine demand and difficulty keeping a residual. Treat the water or fill spa with low phosphate water
- Low salt. Target middle of the green in the SALT meter
- Shock. Boost system or manually add chlorine to clean the water and develop a chlorine residual.
- Cyanuric acid lock. If the Output and Power levels are set to maximum and dichlor or shock has been added daily to supplement the water and the chlorine reading is back to zero ppm the next day, it is possible that the salt system is reacting to the specific water chemistry or metal content and is being inhibited by the cyanuric acid from the dichlor. Typically, this can occur at CYA levels over 50 ppm, however some water chemistries can cause this at 5-10 ppm.
  1. Completely drain the spa
  2. Rinse thoroughly
  3. Refill the spa while using metal and softening treatment, as necessary.
  4. Restart the spa and only use liquid chlorine (sodium hypochlorite) to supplement the spa.

**IMPORTANT** Shock the spa water with chlorine at startup. Skipping this step can prevent the system from establishing a chlorine residual. If metals are present, delay shocking the water until treatment is complete.

### High Chlorine

The system will continue to produce chlorine according to the selected output level, regardless of whether the spa is used or not. If the hot tub is used less frequently, it is important that you lower the output level. Prolonged exposure to elevated

levels of chlorine can damage components and rust the jets. If the chlorine level is too high:

- **Check output level.** You may need to decrease the output level to a lower number.
- **Reduce chlorine.** Add 1 cup (240ml) hydrogen peroxide with jets running.
- **Confirm Power Level.** Lower the power level if setting Output to the lowest level does not reduce chlorine generation enough.

### Issue Diagnosis:

| Condition   | Detail  | Action  |
|---|---|---|
| No WaterCare menu or Icon   | FreshWater Salt not installed                                       | Install FreshWater Salt   |
| Only the FreshWater Salt menu is accessible                                 | Smart Monitoring System not installed                               | Install the Smart Monitoring system   |
|   | Smart Monitoring System is damaged and not communicating to the spa | Inspect the controller and replaceable sensor for damage. Replace components. Contact dealer for additional support           |
| Chlorine and pH missing status and not accessible                           | Message: 24 Hour Initialization Period                              | Sensor is running 24 hour initialization  |
|   | Salt is reporting low red   | Correct the salt level to begin testing   |
| Parameter icons/options (chlorine, pH, Salt) are visible but not accessible | Status indicators are missing                                       | Freshwater Salt in error state  |
|   |   | Smart Monitor "Off"   |
| Spa displaying very different results from a test strip                     | Chlorine  | If a new fill, add a shock dose of chlorine to clear and initialize the water   |
|   |   | If water is 0 ppm and dirty, Boost the Salt System and or add chlorine to recover the water back into the recommended ranges. |
|   | Adjust parameter off-set  |   |
| pH  | pH  | If chlorine is not in the green, correct first  |
|   |   | Adjust parameter off-set  |
| Sensor  | Sensor  | Sensor damaged/ expired, replace  |

### What to do if the Replacement Sensor is dropped into the spa

Quickly remove the sensor and rise with water, distilled water is preferable. Shake all excess water from the part and place in a bag of rice for 48 hours.



## Conditions Affecting System Operation:

| Condition   | Diagnosis / Resolution  |
|---|---|
| Smart Monitoring System not fully seated in the housing   | Cap will not fit – no flow through sensor – erratic readings, sensor damage   |
| Smart Monitoring System seated but not in locked position | Cap will not fit – no flow through sensor – erratic readings, sensor damage   |
| Incomplete start-up process                               | Water not balanced, low chlorine – incorrect sensor readings  |
| Low salt level in water < 1750 ppm                        | pH and chlorine not tested  |
| Low chlorine level < 1 ppm                                | Incorrect pH values   |
| Low alkalinity < 40 ppm                                   | Incorrect pH values   |
| Use of AG+ or silver nitrate products                     | Reading offset – chlorine high, pH low  |
| High chlorine > 10 ppm                                    | May affect readings depending on other water parameters. Spa damage and rust/iron in the water contaminating the sensor |
| Using non-chlorine/Salt system or ozone                   | Incorrect readings  |

## Customer Service

If you have any questions about your FreshWater Smart Monitoring System that have not been answered by this manual, consult your authorized dealer.

For Warranty information, please reference full warranty located in the Smart Monitoring System Start-up Kit Quick Start Guide (PN 63693).

Watkins Wellness® can be reached at:  
1-800-999-4688 (extension 8432) inside the USA or  
+1 760-598-6464 (extension 8432) outside the USA  
Monday through Friday, 8 am to 5 pm Pacific Standard  
Time (PST) or by emailing:  
[customerservice@watkinsmfg.com](mailto:customerservice@watkinsmfg.com).



# Watkins Wellness®

*Feel good. Live well.™*

IMPORTANT: Watkins Wellness reserves the right to change specifications or design without notification and without incurring any obligation.

Watkins Wellness  
1280 Park Center Drive  
Vista, California 92081  
USA

©2024 Watkins Wellness and FreshWater are trademarks of Watkins Wellness registered in the U.S., Canada, CTM and other countries.